

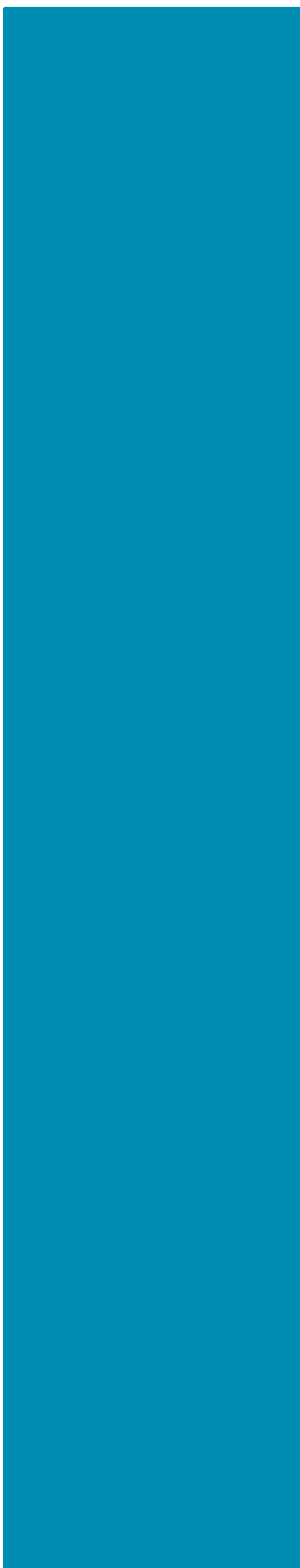

DV Modular Series Quick Installation Guide

202306-00
REV A
Nov 2000





1 Table of contents

Table of contents 3

Copyrights and Trademarks 5

Safety instructions 9

The Jukebox User Interface 13

User Interface Modes 14

Activating the User Interface 15

Info 15

 Element Config. 15

 Storage Config. 15

 Prod. Data. 16

 Mode 16

PIN Codes 17

 Enter Admin PIN 17

 Enter Service PIN. 17

 Change Admin PIN 17

 Change Service PIN. 17

Operate 18

 Element 18

 Pack 19

 Tray 20

Settings 21

 Machine Defaults 21

 Robotic ID 21

Miscellaneous 21

 Show Demo 21

Service 22

 Tidy up 22

Setup 25

Checking the delivery 25

Removing the transportation fixtures 26

Mounting the stands 27

QIGIVZ.fm / 17.10.1996/15.02.2000

2 Copyrights and Trademarks

Notice of Copyright

All rights reserved. Copyright © 1997 - 1999 by DISC, Inc. No part of this publication may be reproduced, stored in a retrieval system, or transmitted, in any form or by any means, electronic, mechanical, photocopying, recording, or otherwise, without the prior written consent of

DISC, Incorporated
372 Turquoise St. Milpitas, CA 95035 USA

Disclaimer

DISC takes no responsibility or warranty with respect of the adequacy of this documentation or the procedures which it describes for any particular purpose or with respect to its adequacy to produce any particular result. In no event shall DISC, its employees, its contractors or the authors of this documentation be liable for special, direct, indirect or consequential damages, losses, costs, charges, claims, demands, or claim for lost profits, fees or expenses of any nature or kind.

Changes

The material in this specification is for information only and is subject to change without notice. While reasonable efforts have been taken in the preparation of this manual to assure its accuracy, DISC assumes no liability resulting from any errors or omissions in this manual, or from the use of the information contained herein.

DISC reserves the right to make changes in the product design without reservation and without notification to its users.

Additional Information may be obtained from:

DISC, Incorporated
372 Turquoise Street
Milpitas, CA 95035
USA

Trademarks Used in this Manual

DISC Logo is a registered trademark of DISC Incorporated

Safety instructions

- **Intended Use**
- **Residual Risks**
- **Safety**



3 Safety instructions

Intended use

The jukeboxes **DV100, DV300, DV400 and DV600** are controlled by a host computer and contain state of the art and very reliable technology. The jukeboxes were exclusively designed to read CD's / DVD's and are capable of recording CD's / DVD's if equipped with recorder drives. The jukeboxes are not intended for any other use.

Improper use of the jukeboxes may cause residual risks if they are used or operated by unauthorized individuals. Any person who uses the jukeboxes should read and understand the user's manual and specially the safety instructions.

Residual risks

In this Quick Installation Guide residual risks are marked as follows:



Warning!

Disregarding the safety messages following "Warning!" can cause damage to the unit.



Danger!

Disregarding the safety messages following "Danger!" can result in personal injury.

Ban of arbitrary reversions and changes

The jukeboxes may not be altered due to applicable safety regulations.

Repairs

Repairs must be carried out only by the DISC service staff, or by qualified and authorized service staff. DISC, Inc will not be liable for any damages caused by alterations or repair by unauthorized individuals.



Warning! Fire damages

To reduce fire or shock hazard, do not expose the units to rain or moisture.

**Warning! Opening the unit**

To prevent electrical shock, remove line cord before opening a unit!

**Danger!**

Disassembling parts and changing of any adjustment, apart from those described in this manual, may result in exposure to hazardous laser radiation!

**Safety**

This product is a Laser Class 1 device. Disk access is carried out by using a laser beam. The laser doesn't represent any risk for the user.

This product complies with the DHHS Rules 21 CFR chapter 1, subchapter J, applicable at the date of manufacturing. Accession number 9520184

Electro Magnetic Compatibility

For the CE certification, the jukeboxes were tested with Adaptec 2940 and 3940 SCSI host adapters. Using any other type of SCSI host adapter, the units might be out of range regarding the electro magnetic emission, especially when the jukebox is equipped with DVD drives.

The Jukebox User Interface

- User Interface Diagram
- User Interface Modes
- Activation the User Interface
- Info
- PIN Codes
- Operate
- Settings
- Miscellaneous
- Service

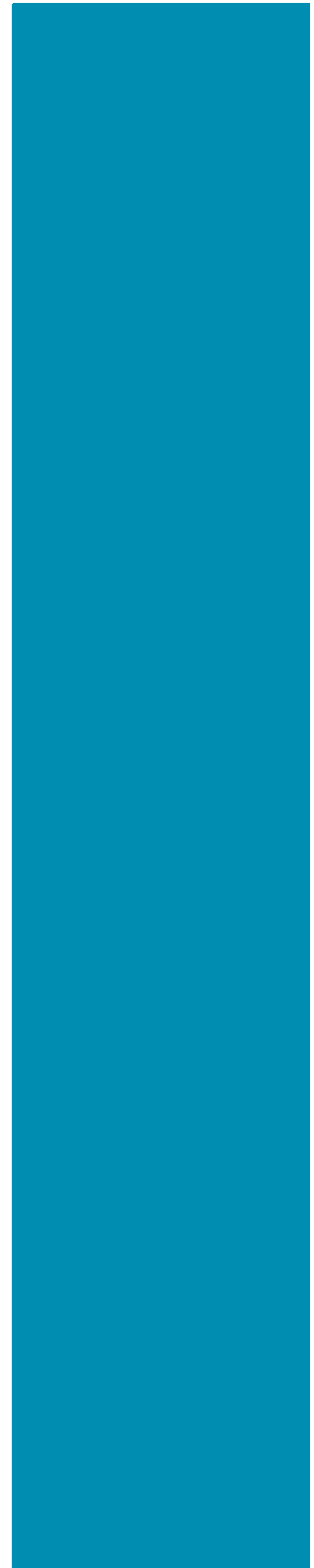

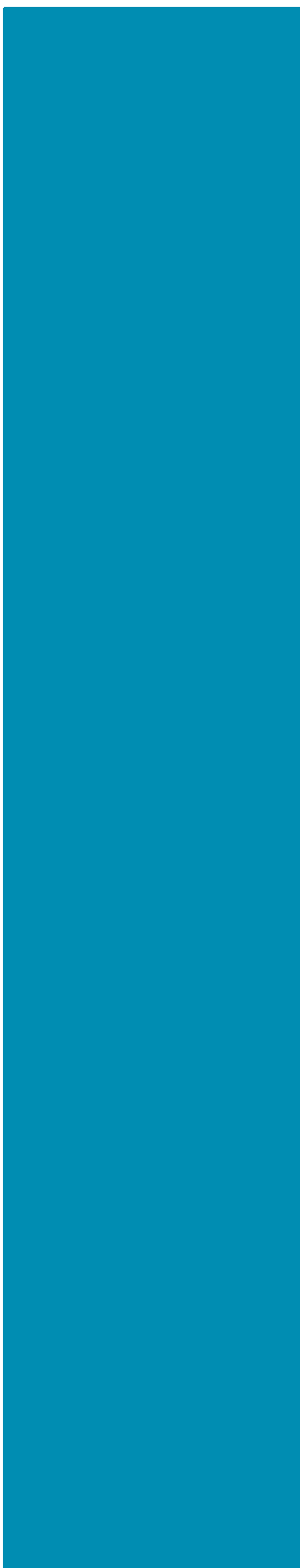



4 The Jukebox User Interface

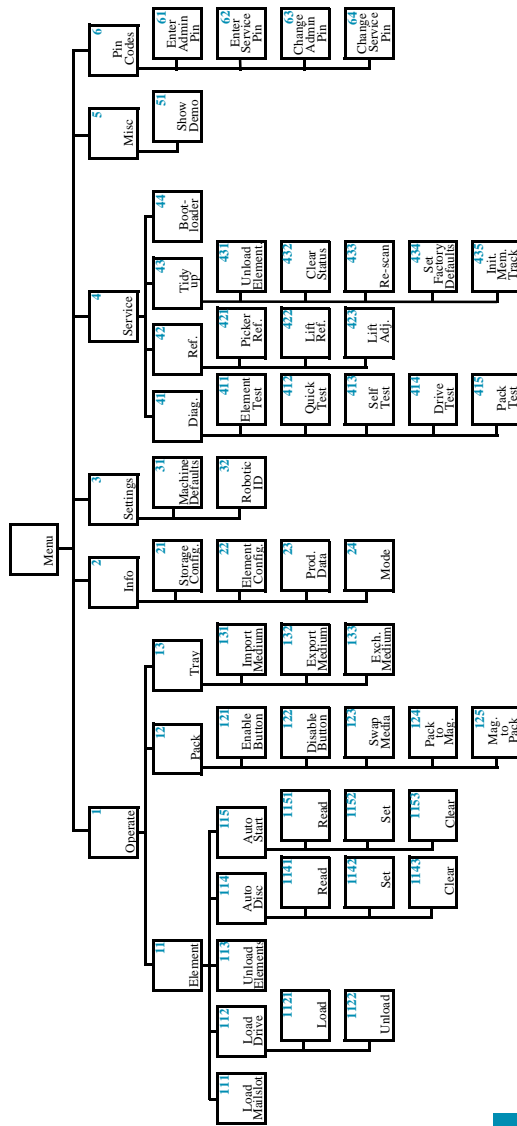

3.1 User Interface Modes

The User Interface of the

DV600

DV400

DV300

DV100

can be used to configure and operate the jukebox without using a host application. The User Interface has 3 different modes:

User Mode

In the **User Mode** only the **Info** and **Pin Codes** menu are available. In this mode no settings can be changed or operations performed.

Admin Mode

The **Admin Mode** can be activated by entering the **Admin PIN**. In the **Admin Mode** all necessary settings for installing the jukebox can be done. In this mode it is also possible to fully operate the jukebox without using a host application.

Service Mode

The **Service Mode** can be activated by entering the **Service PIN**. The functions available in the Service Menu should only be used by trained technicians. Unauthorized use of these functions can cause serious problems.

The factory default for both PIN Codes is **9999**.

The availability of functions in the User mode might change when the jukebox is controlled by a host application.

The Jukebox User Interface

Activating the User Interface

4.1 Activating the User Interface

The Jukebox User Interface can be activated by pressing the **F7** key.

NSM Vxxxx 01/03/99

User Menu Select Item

NSM Vxxxx 01/03/99

To navigate through the User Interface, use the **←** and **→** buttons for horizontal movement. Use **ENTER** and **ESC** for vertical movement.

To leave the User Interface, go to the menu root (1) and press the **ESC** key. The jukebox will leave the User Interface automatically when the jukebox is not in a submenu where settings can be edited / changed and no button has been pushed for 10 minutes.

4.2 Info

The **Info** menu gives information about the jukebox configuration and capacity.

4.2.1 Element Config.

Element Config. gives information about the equipment of the jukebox. Information shown in this menu is:

- mailslot available (yes / no)
- position of drives in jukebox
- type of drives
- SCSI ID's of drives

D01: WR SCSI ID 5 Plextor PXR 412

4.2.2 Storage Config.

Storage Config. gives information about the capacity of the jukebox. Information shown in this menu is:

- Total amount of media (number of CD's / DVD's present in jukebox)

The Jukebox User Interface

Info

- Total amount of slots
- On-line removable (number of trays in packs at front of jukebox)

4.2.3 Prod. Data

Prod Data gives information about the production data of the jukebox. Information shown in this menu is:

- Vendor ID
- Product ID
- Revision Level
- Production Date
- Part Number
- Serial Number
- FW (Firmware) Release
- FW (Firmware) Date

4.2.4 Mode

The **Mode** menu gives information about the robotics mode (RS 232 controlled robotic or SCSI controlled robotic) of the jukebox.



4.3 PIN Codes

In the **PIN Codes** menu the pin codes can be entered and changed. The factory default for **Admin PIN** and **Service PIN** is **9999**.

4.3.1 Enter Admin PIN

After entering the **Admin PIN** and confirming with the **'ENTER'** button all functions of the **Operate** menu and the **Settings** menu are available.

4.3.2 Enter Service PIN

After entering the **Service PIN** and confirming with the **'ENTER'** button all functions of the User Interface are available.

4.3.3 Change Admin PIN

To change the **Admin PIN**, enter the new **Admin PIN** and confirm with the **'ENTER'** button. The **Admin PIN** can only be changed when the original **Admin PIN** has been entered before.

4.3.4 Change Service PIN

To change the **Service PIN**, enter the new **Service PIN** and confirm with the **'ENTER'** key. The **Service PIN** can only be changed when the original **Service PIN** has been entered before.



*If a PIN is set to **0000**, this PIN protection is switched off.*

The Jukebox User Interface

Operate

4.4 Operate

In the **Operate** menu the Galaxy offers several functions to control and to operate the jukebox without host software.



The functions of the Operate menu should not be used while the jukebox is connected to a host software.

4.4.1 Element

Load Mailslot

The **Load Mailslot** function can be used to import or export a single medium. The jukebox will guide you through the steps which are necessary to select a tray inside the jukebox. The address of the tray consists of 5 digits.

Element	
Load Mailslot	
Tray	1 = Front
>----<	2 = Rear
Tray	Bay
>X---<	1-16
Tray	Tray
>XX--<	1-15/50

Digit	Meaning	Parameters
1	Location (front or back of jukebox)	1 - 2
2+3	Position (bay) of pack or magazine	1 - 16
4+5	Position of tray inside pack or magazine	01 - 15 / 50

After typing the numbers, press the **'Enter' key** to load the tray to the mailslot. Press the **'Enter' key** if you want to import or export another medium and type the address of the next tray. If the importing or exporting of media is finished press the button beside the mailslot to close the mailslot, the tray will be unloaded from the mailslot after a few seconds.

Load Drive

The **Load Drive** function can be used to move and load a medium to any drive of the unit. The procedure of loading a medium to a drive is similar to loading a medium to the mailslot.

Unload Elements

The **Unload Elements** function can be used to return all trays from the drives and the mailslot to the packs and magazines.



Auto Disc

The **Auto Disc** function can be set for one of the media inside the unit. If the **Auto Disc** function is set, the medium will be moved and loaded to a drive automatically when the jukebox is powered up. The Auto Disc function can be used to start the complete system from a bootable medium. Parameters for the **Auto Disc** function are the position of the drive (bay) that should be used and the address of the medium (front or rear of jukebox; bay number; tray number) that should be loaded to the drive.

Auto Start

If the **Auto Start** function is activated, media which are inside drives of the jukebox will be mounted automatically after powering up the jukebox.

4.4.2 Pack

Enable Button

The **Enable Button** function can be used to release a single pack of the Galaxy when the pack buttons are disabled by a host application.

Disable Button

After reinserting a pack which was released with the **Enable Button** function, the pack button should be disabled again to give back full control to the host application.

Swap Media

The **Swap Media** function can be used to move the complete contents of a pack (front of jukebox) to a magazine in the back of the jukebox or to bring back the CD's from a magazine to a pack. parameters for the **Swap Media** function are the source pack (front or rear of jukebox; bay) and the destination magazine (front or rear of jukebox; bay, number of first slot that should be used for the exchange).

Pack to Mag.

The **Pack to Mag.** function can be used to move **all** media located in packs at the front of the jukebox to magazines.

The **Pack to Mag.** function is a very fast way to import media to the jukebox.

Mag. to Pack

The Mag. to Pack function can be used to export all media from magazines. The media are moved to the packs, the operations stops when no more empty slots in packs are available and carries on as soon as an empty pack is inserted.

4.4.3 Tray

Import Medium

The **Import Medium** function can be used to import several media to the jukebox. After the import of the first medium, as long as the mailslot is closed with the **'Enter' key**, the unit will automatically load the next empty tray to the mailslot to import the next CD. When the importing of media is finished, after importing the last medium, the operation can be stopped by pressing the **'ESC' key**, the jukebox will bring the medium to the pack or magazine and then stops.

Exchange Medium

The **Exchange Medium** function can be used to move a single medium to another storage element (pack or magazine) inside the jukebox. Parameters for the **Exchange Medium** function are the source tray (front or rear of jukebox; bay of pack or magazine; position of tray in pack or magazine) and the destination tray (front or rear of jukebox; bay of pack or magazine; position of tray in pack or magazine). After all parameters are entered, the source and destination tray are swapped.

4.5 Settings

4.5.1 Machine Defaults

The jukebox **Machine Defaults** are special presets which can be used by a host application to configure the jukebox. All jukeboxes are originally set to **Machine Default No. 21**.

A host application might change the **Machine Default** to another value. In the **Machine Defaults** menu, the **Machine Default** can be changed by the user by using the \leftarrow and \rightarrow buttons. The setting can be stored by pressing the 'ENTER' key.



In some Machine Defaults the packs can only be controlled by the host software.

If the jukebox should be operated in SCSI mode, the Machine Default has to be set to 21.

4.5.2 Robotic ID

(DV100 only)

In the **Robotic ID** menu the serial robotic ID (RS 232 ID) and the SCSI robotic ID (if the unit is equipped with SCSI controlled robotic) can be set / changed.

4.6 Miscellaneous

4.6.1 Show Demo

The **Show Demo** can be used to give a demonstration of the jukebox robotic. When the **Show Demo** is activated, the jukebox will load and unload trays to the drives and the mailslot automatically. The **Show Demo** can be stopped by pressing the 'ESC' key. Depending on the **Machine Default** of the unit, the **Show Demo** might change the **Machine Default**. When the jukebox is reconnected to a host application, the **Machine Default** will be changed by the application automatically if needed.

4.7 Service



The functions available in the Service Menu should only be used by trained technicians. Unauthorized use of these functions can cause serious problems. A detailed description of the service functions can be found in the Galaxy Service Manual.

4.7.1 Tidy up

Set Factory Defaults

With the **Set Factory Defaults** function, the jukebox can be reset to the factory defaults.

In case of communication problems between jukebox and host application, please reset the factory defaults and try again before you call DISC technical support.

Clear Status

With the Clear Status function all status information of the drives, the lift and the mailslot can be deleted.



Before this function can be used, all trays must be unloaded from drives and mailslot. If the status of the jukebox is cleared while trays are inside a drive or the mailslot the jukebox will not be able to operate.

Re-scan

After activating the Re-scan function, the jukebox will scan all trays for media again.

Setup

- **Checking the delivery**
- **Removing the transportation fixtures**
- **Mounting the stands**
- **Placing the jukebox**
- **Operation Modes**
- **Setting the SCSI ID's for the drives**
- **Connecting to a host computer**
- **Connecting line voltage**

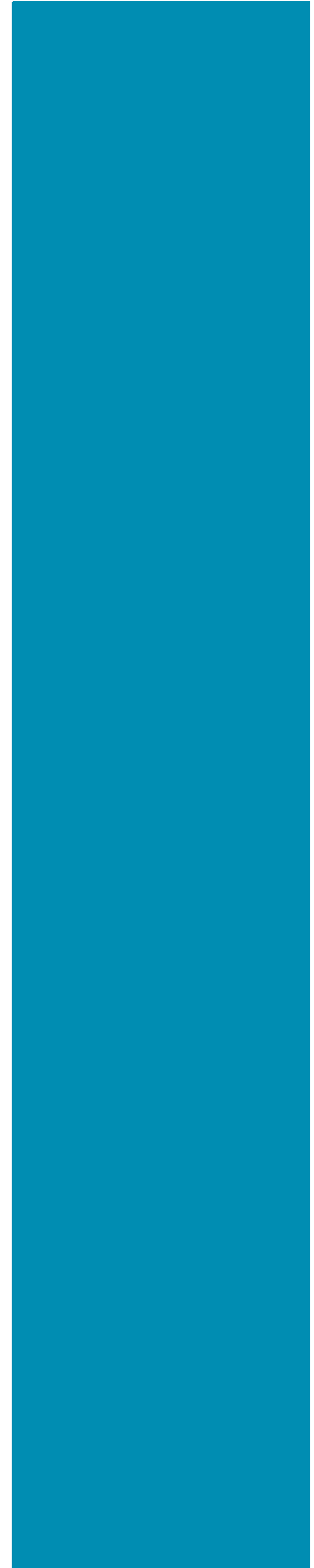

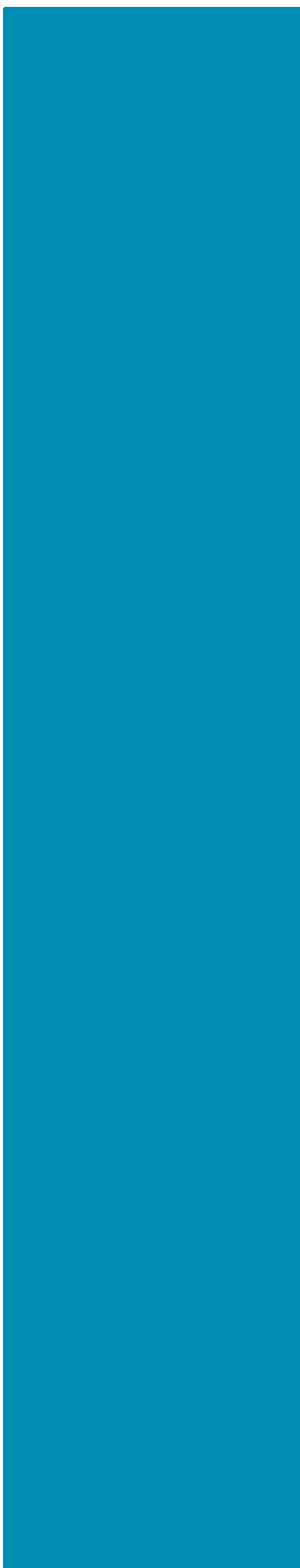



5 Setup

5.1 Checking the delivery

Delivery	
Power cord	3
Ferrite (DV600/400/300 only)	1
RS 232 cable (not for DV100 SCSI)	1
SCSI terminator	1 per SCSI bus
Quick Installation Guide	1
User Manual CD	1
Stands (DV600 and DV400 only)	4
Jukebox	1

Setup

Removing the transportation fixtures

5.2 Removing the transportation fixtures

DV600/400/300

A detailed description how to remove the transportation fixtures can be found on the packaging of the jukebox.

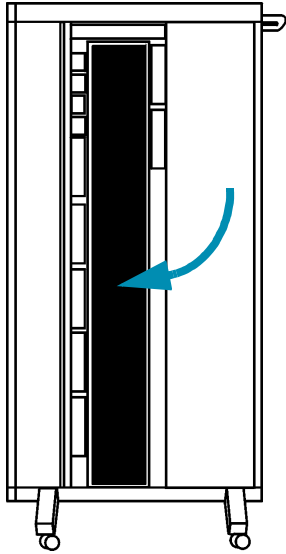

DV100

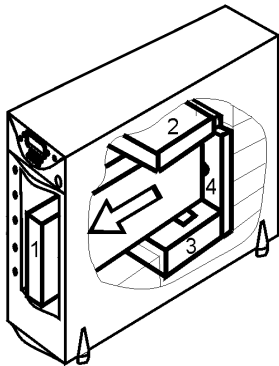

- Remove the 4 inlays which are placed inside the jukebox
- Remove the blue caps from the packs
- Insert the packs



5.3 Mounting the stands



For security reasons, the DV600/400/300 jukeboxes must not be operated without the stands. To mount the stands of the DV600/400/300 jukeboxes two persons are needed.

- Tilt the jukebox a little bit to the left and push the two stands for the right side into the holes at the bottom of the jukebox until the stands "click" in.
- Tilt the jukebox a little bit to the right and push the two stands for the right side into the holes at the bottom of the jukebox until the stands "click" in.

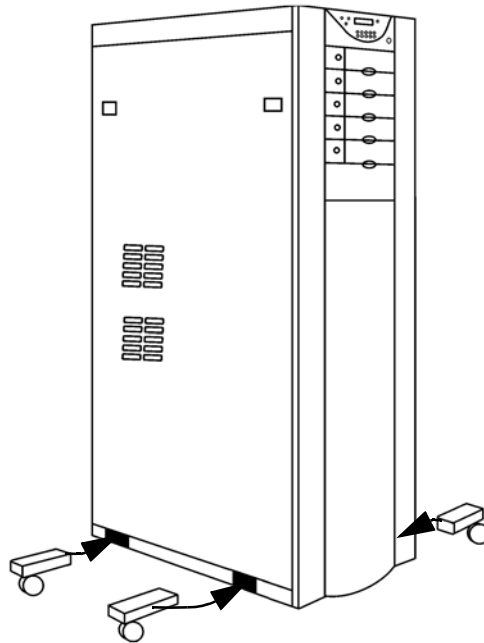

5.4 Placing the jukebox

The DV600/400/300 and 100, jukeboxes are intended for the use in offices and computer networks.



After delivery the temperature of the jukebox should be adapted slowly to the temperature of the room before powering up the jukebox.

Avoid places with

- extreme temperatures or excessive sun exposure
- high humidity
- contact with water or chemicals
- extreme vibrations

The right location

- has a stable, even support
- has sufficient space to pull out the unit



DV600/400/300

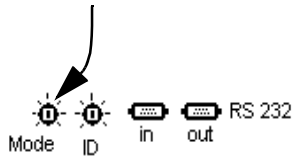

The DV600/400/300 jukebox offers several operation modes which can be selected by the mode select switch at the back of the jukebox. The function of the ID switch depends on the selected mode. Which mode has to be selected depends on the host application which is used to control the robotic of the jukebox.

Mode	Function	Function of ID switch
0	RS 232 mode	RS 232 ID (robotic)
1	SCSI mode	SCSI ID (robotic)
2 - F	internal use only	-----

DV100

If a DV100 jukebox is equipped with the SCSI controlled robotics, the jukebox is in SCSI mode as long as no serial cable is connected to the RS 232 interface of the unit.

For information how to change the robotic ID see chapter 4.

5.5.1 RS 232 Mode

The RS 232 mode has to be selected if the robotic of the jukebox should be controlled via the serial interface (RS 232). The factory default for the RS 232 ID is 00. The ID only needs to be changed, if more than one jukebox should be connected to the serial bus.



Do not connect more than 3 jukeboxes to the serial bus. If more than 3 jukeboxes are connected to the serial bus, the signal might be disturbed.



The maximum cable length of the serial bus must not exceed 15 m.

Setup

SCSI cable requirements

5.5.2 SCSI mode

The SCSI mode has to be selected if the jukebox should be controlled over the SCSI bus. In the SCSI mode the ID switch is used to select the SCSI ID of the jukebox robotic.



If SCSI mode is selected, the robotic of the jukebox allocates a SCSI ID on the SCSI bus.

The ID range for the robotic SCSI ID is 00 to 07.

5.6 SCSI cable requirements



To have a reliable data transfer, use only shielded high quality SCSI cables. For additional information about SCSI cables see the SCSI-2 Specification.

5.6.1 SCSI cable length single ended SCSI

SCSI Mode	Maximum cable length
Asynchronous mode	6 m
Fast SCSI (synchronous mode)	3 m
Ultra SCSI	1.5 m

5.6.2 SCSI cable length LVD

The maximum SCSI cable length for LVD (Low Voltage Differential) is 12 m.

5.7 Setting the SCSI ID's for the drives

The SCSI ID's of the drives of the DV600/400/300 can be set with the ID switches at the back of the jukebox.

Use a small screw driver to change the ID setting. The ID range for each drive is 00 to 07. For additional information about the drive assignment of the jukebox see the configuration protocol which is attached to the Quick installation guide.

DV600/400/300

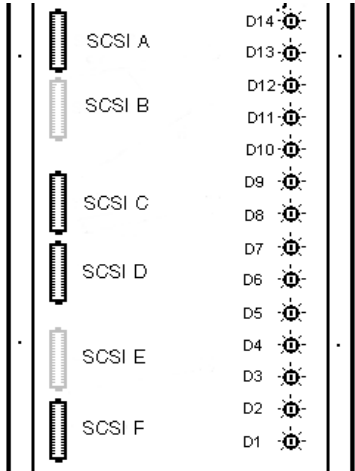

DV100



Kap3.fm/ 03.06.1999/15.02.2000

Setup

Connecting to a host computer

5.8 Connecting to a host computer

5.8.1 Connecting the serial robotic interface



Turn off the jukebox and the host computer when connecting the cables.

Depending on the software which is used to control the robotic of the jukebox, the serial interface (RS 232) of the jukebox needs to be connected to the host computer.

Via the RS 232 interface all mechanical operations like loading media, unloading media, importing or exporting media can be controlled. The RS 232 ID for the robotic is set to 00 by factory default. This setting needs to be changed only when more than one jukebox should be connected to the serial bus.

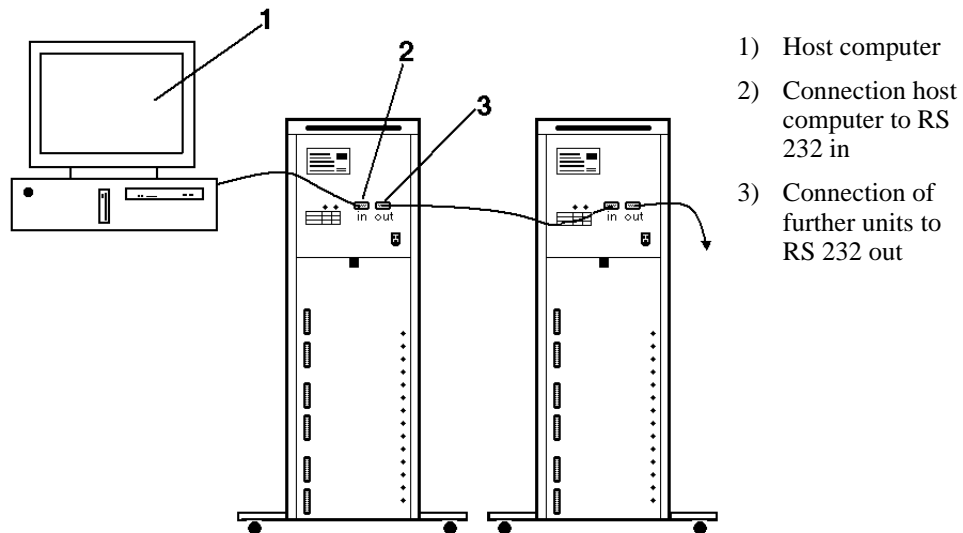

5.8.2 Connecting the SCSI interfaces



Turn off the jukebox and the host computer when connecting the SCSI cables.



The second connector of each SCSI bus can be used to daisy chain further SCSI devices if free SCSI ID's are available on the SCSI bus.

For information about the drive configuration of your jukebox see the configuration protocol which is attached to the Quick Installation Guide.

If the connector is not used for daisy chaining, the bus has to be terminated with an external SCSI bus terminator.

If the jukebox should be operated in SCSI mode (robotic is controlled via the SCSI bus), the robotic interface is connected to the first SCSI bus (SCSI A).

The DV600 can be equipped with 2 or 3 SCSI busses. The DV100 is always equipped with 2 SCSI buses (SCSI A and SCSI B).

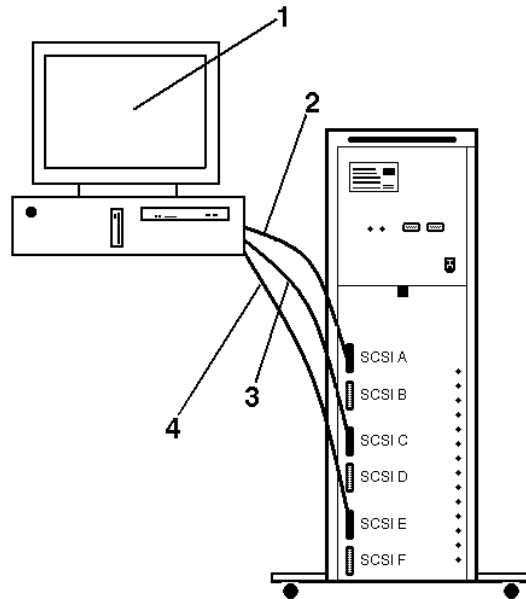

- 1) Host computer
- 2) Connection SCSI bus A to host computer
- 3) Connection SCSI bus B to host computer
- 4) Connection SCSI bus C to host computer

5.9 Connecting line voltage

Before connecting the jukebox to mains, mount the ferrite to the power chord. The ferrite has to be mounted as close to the jukebox as possible (DV600/400/300 only).

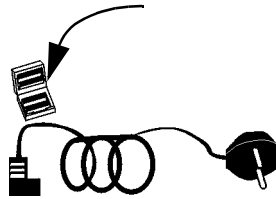

All DV Series jukeboxes have auto switching power supply units; no settings for line voltage are required.



The switched OFF jukebox is not electrically disconnected from the line voltage. If you want to disconnect the jukebox completely from the line voltage, you will have to remove the power cord.



The DV600 jukebox has to be connected to an electrical circuit which is secured by a 16 A fuse.

5.10 COMET Storage Manager

The Comet jukebox is delivered with the **COMET Storage Manager** Software for Windows NT. For a detailed description of the software see the **COMET Storage Manager** User Manual on the COMET Manuals CD.

5.10.1 System Requirements

- Intel Pentium based system with 120 MHz minimum
- Windows NT 4.0 Workstation or Server for server installation,
- Windows NT, Windows 95 or Windows 98 for client installation
- 64 MB RAM
- minimum of 2 MB hard disk space per 1 GB Medium space plus space for cached data (50 MB minimum)

5.10.2 Software Installation

- 1) For a server installation log on as member of the local administrator's group.
- 2) If the installation wizard does not start automatically execute the
- 3) file "E:\setup.exe" (where E represents the CD-ROM drive letter).
- 4) Please read first the ReadMe information.
- 5) Follow the instructions of the installation program.

5.11 Jukebox Manager DV100

The DV100 jukebox is delivered with the **Jukebox Manager DV100** Software for Windows NT. For a detailed description of the software see the **Jukebox Manager DV100** User Manual.

5.11.1 System Requirements

- Intel Pentium based system with 120 MHz minimum
- Windows NT 4.0 Workstation or Server for server installation,
- Windows NT, Windows 95 or Windows 98 for client installation
- 32 MB RAM (64 recommended)
- Minimum of 1.6 MB hard disk space per CD plus space for cached data (50...2048MB)

5.11.2 Software Installation

- 1) For a server installation log on as member of the local administrator's group.
- 2) If the installation wizard does not start automatically execute the
- 3) file "E:\setup.exe" (where E represents the CD-ROM drive letter).
- 4) Please read first the ReadMe information.
- 5) Follow the instructions of the installation program.

Appendix

- Technical Data

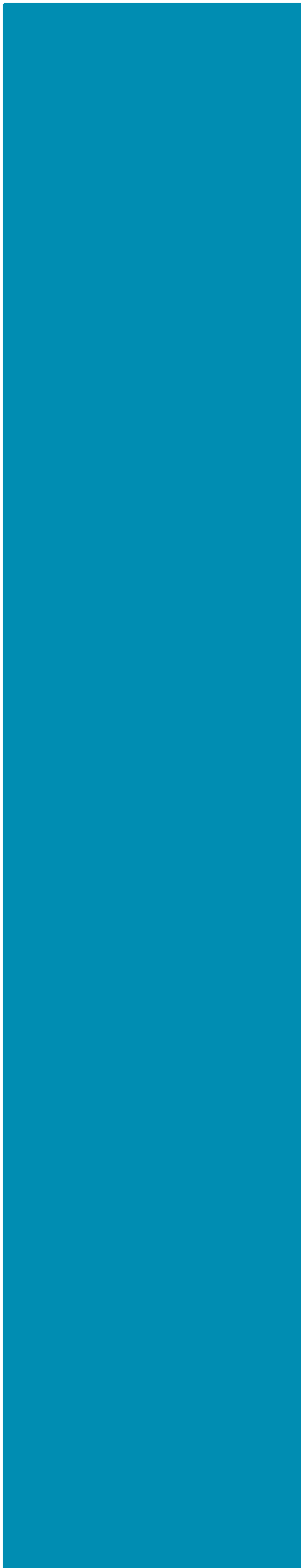



6 Appendix - Technical Data

6.1 COMET /DV100

Factory settings		
RS232-interface	RS232-ID	0
	Baud rate	9600 Baud
	Number of start bits	1
	Number of data bits	8
	Number of stop bits	1
	Parity check	no parity
SCSI interface	SCSI Robotic ID	1
Operating conditions		
Ambient temperature		
Operating	10°C – 37°C	50°F – 98,6°F
Model with 3 CD-R drives	10°C – 30°C	50°F – 86°F
Gradient of temperature	11°C/h	19,8°F/h
Relative humidity operating	10 % – 75 %	non condensing
Power supply		
Line voltage	90 V - 264 V	
Frequency range	47 Hz - 63 Hz	
Power consumption normal	60 W	
Power consumption max.	130 W	
Dimension and Weight		
Dimension	Width 220 mm	
	Height 410 mm	
	Depth 644 mm	
Weight without media	35 kg	

Kap4.fm/ 31.01.1997/15.02.2000

6.2 DV600

Factory settings		
RS232 interface	RS232-ID	0
	Baud rate	9600 Baud
	Number of start bits	1
	Number of data bits	8
	Number of stop bits	1
	Parity check	no parity
SCSI interface	SCSI Robotic ID	0
Operating conditions		
Ambient temperature		
Operating	10°C – 40°C	50°F – 104°F
Gradient of temperature	11°C/h	19,8°F/h
Relative humidity operating	10 % – 75 %	non condensing
Power supply		
Line voltage	90 V - 240 V	
Frequency range	47 Hz - 63 Hz	
Power consumption normal	220 W	(machine with 14 drives)
Power consumption max.	400 W	(machine with 14 drives)
Dimension and Weight		
Dimension	Width 620,5 mm	(with stands)
	Height 1300 mm	
	Depth 730 mm	
Weight without media	85 kg	(model with 6 drives)



For information about the drive configuration and the capacity of your jukebox see the configuration protocol which is attached to the Quick Installation Guide.



6.3 DV400

Factory settings		
RS232 interface	RS232-ID	0
	Baud rate	9600 Baud
	Number of start bits	1
	Number of data bits	8
	Number of stop bits	1
	Parity check	no parity
SCSI interface	SCSI Robotic ID	0
Operating conditions		
Ambient temperature		
Operating	10°C – 40°C	50°F – 104°F
Gradient of temperature	11°C/h	19,8°F/h
Relative humidity operating	10 % – 75 %	non condensing
Power supply		
Line voltage	90 V - 240 V	
Frequency range	47 Hz - 63 Hz	
Power consumption normal	140 W	
Power consumption max.	220 W	
Dimension and Weight		
Dimension	Width 620,5 mm	(with stands)
	Height 980 mm	
	Depth 730 mm	
Weight without media	69 kg	(model with 7drives)

Kap4.fm/31.01.1997/15.02.2000



For information about the drive configuration and the capacity of your jukebox see the configuration protocol which is attached to the Quick Installation Guide.

6.4 DV300

Factory settings		
RS232 interface	RS232-ID	0
	Baud rate	9600 Baud
	Number of start bits	1
	Number of data bits	8
	Number of stop bits	1
	Parity check	no parity
SCSI interface	SCSI Robotic ID	0
Operating conditions		
Ambient temperature		
Operating	10°C – 40°C	50°F – 104°F
Gradient of temperature	11°C/h	19,8°F/h
Relative humidity operating	10 % – 75 %	non condensing
Power supply		
Line voltage	90 V - 240 V	
Frequency range	47 Hz - 63 Hz	
Power consumption normal	140 W	
Power consumption max.	220 W	
Dimension and Weight		
Dimension	Width 487 mm	(with stands)
	Height 780 mm	
	Depth 730 mm	
Weight without media	54 kg	(model with 6 drives)



For information about the drive configuration and the capacity of your jukebox see the configuration protocol which is attached to the Quick Installation Guide.

Agency Approvals

- FCC Declaration
- Declaration Of Conformity

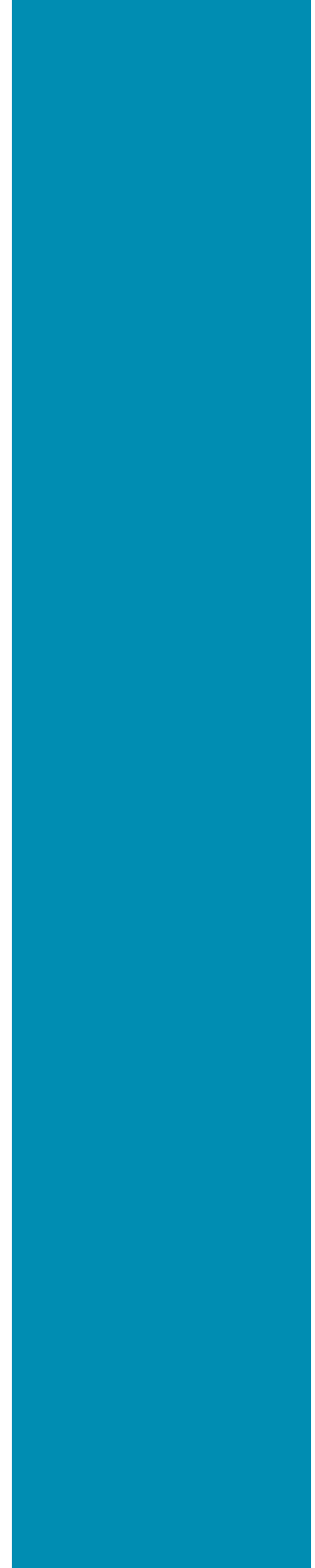



7 Agency Approvals

7.1 FCC declaration

This equipment has been tested and found to comply with the limits for a Class B digital device, pursuant to Part 15 of the FCC Rules. These limits are designed to provide reasonable protection against harmful interference in a residential installation. This equipment generates, uses, and can radiate radio frequency energy and, if not installed and used in accordance with the instructions, may cause harmful interference to radio communications. However, there is no guarantee that interference will not occur in a particular installation. If this equipment does cause harmful interference to radio or television reception, which can be determined by turning the equipment on and off, the user is encouraged to try to correct the interference by one or more of the following measures:

- Reorient or relocate the receiving antenna.
- Increase the separation between the equipment and receiver.
- Connect the equipment into an outlet on a circuit different from that to which the receiver is connected.
- Consult the dealer or an experienced radio/TV technician for help.

Important: This product was FCC verified under test conditions that include use of shielded cables and connectors between system components. It is important that you use shielded cables and connectors to reduce the possibility of causing interference to radios, TV sets, and other electronic devices.

Should you have any problems contact your dealer.

Any change or modifications to the equipment by the user not expressly approved by the grantee or manufacturer could void the user's authority to operate such equipment.

Agency Approvals



DV100

EG-Konformitätserklärung	EC-Declaration of Conformity	CE-Déclaration de Conformité
<p>mit den Richtlinien 89 / 336 / EWG und 73 / 23 / EWG.</p> <p>Hiermit wird bestätigt, daß das Produkt</p> <p style="text-align: center;">CD-ROM Jukebox</p> <p>mit den folgenden Normen bzw. normativen Dokumenten übereinstimmt:</p> <p>EN 55022: 1997 Kategorie B Grenzwerte und Meßverfahren für Funkstörungen von informationstechnischen Einrichtungen.</p> <p>EN 50082-1: 1997 Störfestigkeit von informationstechnischen Einrichtungen.</p> <p>EN 60950 A4, A11 Sicherheit von Einrichtungen der Informationstechnik.</p> <p>Das Qualitätssicherungssystem der DISC garantiert die Konformität.</p> <p>Ausstelldatum: 14.02.2000</p>	<p>per 89 / 336 / EEC and 73 / 23 / EWG.</p> <p>This is to confirm with that the product</p> <p style="text-align: center;">CD-ROM Jukebox</p> <p>is in compliance with the following standards or other normative documents:</p> <p>EN 55022: 1997 class B Limits and methods of radio interference characteristics of information technology equipment.</p> <p>EN 50082-1: 1997 Information technology equipment-Immunity Characteristics- Limits and methods of measurement.</p> <p>EN 60950 A4, A11 Safety of information technology equipment.</p> <p>DISC quality assurance system assures compliance.</p> <p>Date of issue of the declaration: 02-14-2000</p>	<p>avec 89 / 336 / CEE et 73 / 23 / EWG.</p> <p>Nous déclarons que le produit</p> <p style="text-align: center;">Jukebox CD-ROM</p> <p>est conforme aux normes ou autres documents normatifs suivants:</p> <p>EN 55022: 1997 class B Limites et méthodes de mesure des caractéristiques de perturbation radioélectriques produites par les appareils de traitement de information.</p> <p>EN 50082-1: 1997 Appareils de traitements information - caractéristiques d'immunité - limites et méthodes de mesure.</p> <p>EN 60950 A4, A11 Sécurité des matériels de traitement de information.</p> <p>La système assurance de la qualité de DISC garantit la conformité.</p> <p>Date d'établissement 7e la déclaration: 14.02.2000</p>

Kap.5.fm/31.01.1997/15.02.2000



EG-Konformitätserklärung	EC-Declaration of Conformity	CE-Déclaration de Conformité
<p>mit den Richtlinien 89 / 336 / EWG und 73 / 23 / EWG.</p> <p>Hiermit wird bestätigt, daß das Produkt</p> <p style="text-align: center;">CD-ROM Jukebox</p> <p>mit den folgenden Normen bzw. normativen Dokumenten übereinstimmt:</p> <p>EN 55022: 1998 Kategorie B Grenzwerte und Meßverfahren für Funkstörungen von informationstechnischen Einrichtungen.</p> <p>EN 55024: 1998 Störfestigkeit von informationstechnischen Einrichtungen.</p> <p>EN 60950 A4, A11 Sicherheit von Einrichtungen der Informationstechnik.</p> <p>Das Qualitätssicherungssystem der DISC garantiert die Konformität.</p> <p>Hersteller:</p> <p>Ausstelldatum: 14.02.2000</p>	<p>per 89 / 336 / EEC and 73 / 23 / EWG.</p> <p>This is to confirm with that the product</p> <p style="text-align: center;">CD-ROM Jukebox</p> <p>is in compliance with the following standards or other normative documents:</p> <p>EN 55022: 1998 class B Limits and methods of radio interference characteristics of information technology equipment.</p> <p>EN 55024: 1998 Information technology equipment-Immunity Characteristics- Limits and methods of measurement.</p> <p>EN 60950 A4, A11 Safety of information technology equipment.</p> <p>DISC quality assurance system assures compliance.</p> <p>Manufacturer:</p> <p>Date of issue of the declaration: 02-14-2000</p>	<p>avec 89 / 336 / CEE et 73 / 23 / EWG.</p> <p>Nous déclarons que le produit</p> <p style="text-align: center;">Jukebox CD-ROM</p> <p>est conforme aux normes ou autres documents normatifs suivants:</p> <p>EN 55022: 1998 class B Limites et méthodes de mesure des caractéristiques de perturbation radioélectriques produites par les appareils de traitement de l'information.</p> <p>EN 55024: 1998 Appareils de traitements l'information - caractéristiques d'immunité - limites et méthodes de mesure.</p> <p>EN 60950 A4, A11 Sécurité des matériels de traitement de l'information.</p> <p>La système d'assurance de la qualité de DISC garantit la conformité.</p> <p>Fabricant:</p> <p>Date d'établissement de la déclaration: 14.02.2000</p>

Kap5.fm/31.01.1997/15.02.2000

Agency Approvals



EG-Konformitätserklärung	EC-Declaration of Conformity	CE-Déclaration de Conformité
<p>mit den Richtlinien 89 / 336 / EWG und 73 / 23 / EWG.</p> <p>Hiermit wird bestätigt, daß das Produkt</p> <p style="text-align: center;">CD-ROM Jukebox</p> <p>mit den folgenden Normen bzw. normativen Dokumenten übereinstimmt:</p> <p>EN 55022: 1997 Kategorie B Grenzwerte und Meßverfahren für Funkstörungen von informationstechnischen Einrichtungen.</p> <p>EN 50082-1: 1997 Störfestigkeit von informationstechnischen Einrichtungen.</p> <p>EN 60950 A4, A11 Sicherheit von Einrichtungen der Informationstechnik.</p> <p>Das Qualitätssicherungssystem der DISC garantiert die Konformität.</p> <p>Hersteller:</p> <p>Ausstelldatum: 14.02.2000</p>	<p>per 89 / 336 / EEC and 73 / 23 / EWG.</p> <p>This is to confirm with that the product</p> <p style="text-align: center;">CD-ROM Jukebox</p> <p>is in compliance with the following standards or other normative documents:</p> <p>EN 55022: 1997 class B Limits and methods of radio interference characteristics of information technology equipment.</p> <p>EN 50082-1: 1997 Information technology equipment-Immunity Characteristics- Limits and methods of measurement.</p> <p>EN 60950 A4, A11 Safety of information technology equipment.</p> <p>DISC quality assurance system assures compliance.</p> <p>Manufacturer:</p> <p>Date of issue of the declaration: 02-14-2000</p>	<p>avec 89 / 336 / CEE et 73 / 23 / EWG.</p> <p>Nous déclarons que le produit</p> <p style="text-align: center;">Jukebox CD-ROM</p> <p>est conforme aux normes ou autres documents normatifs suivants:</p> <p>EN 55022: 1997 class B Limites et méthodes de mesure des caractéristiques de perturbation radioélectriques produites par les appareils de traitement de l'information.</p> <p>EN 50082-1: 1997 Appareils de traitements l'information - caractéristiques d'immunité - limites et méthodes de mesure.</p> <p>EN 60950 A4, A11 Sécurité des matériels de traitement de l'information.</p> <p>La système d'assurance de la qualité de DISC garantit la conformité.</p> <p>Fabricant:</p> <p>Date d'établissement 7e la declaration: 17.02.2000</p>



EG-Konformitätserklärung	EC-Declaration of Conformity	CE-Déclaration de Conformité
<p>mit den Richtlinien 89 / 336 / EWG und 73 / 23 / EWG.</p> <p>Hiermit wird bestätigt, daß das Produkt</p> <p style="text-align: center;">CD-ROM Jukebox</p> <p>mit den folgenden Normen bzw. normativen Dokumenten übereinstimmt:</p> <p>EN 55022: 1997 Kategorie B Grenzwerte und Meßverfahren für Funkstörungen von informationstechnischen Einrichtungen.</p> <p>EN 50082-1: 1997 Störfestigkeit von informationstechnischen Einrichtungen.</p> <p>EN 60950 A4, A11 Sicherheit von Einrichtungen der Informationstechnik.</p> <p>Das Qualitätssicherungssystem der DISC garantiert die Konformität.</p> <p>Hersteller:</p> <p>Ausstelldatum: 14.02.2000</p>	<p>per 89 / 336 / EEC and 73 / 23 / EWG.</p> <p>This is to confirm with that the product</p> <p style="text-align: center;">CD-ROM Jukebox</p> <p>is in compliance with the following standards or other normative documents:</p> <p>EN 55022: 1997 class B Limits and methods of radio interference characteristics of information technology equipment.</p> <p>EN 50082-1: 1997 Information technology equipment-Immunity Characteristics- Limits and methods of measurement.</p> <p>EN 60950 A4, A11 Safety of information technology equipment.</p> <p>DISC quality assurance system assures compliance.</p> <p>Manufacturer:</p> <p>Date of issue of the declaration: 02-14-2000</p>	<p>avec 89 / 336 / CEE et 73 / 23 / EWG.</p> <p>Nous déclarons que le produit</p> <p style="text-align: center;">Jukebox CD-ROM</p> <p>est conforme aux normes ou autres documents normatifs suivants:</p> <p>EN 55022: 1997 class B Limites et méthodes de mesure des caractéristiques de perturbation radioélectriques produites par les appareils de traitement de l'information.</p> <p>EN 50082-1: 1997 Appareils de traitements l'information - caractéristiques d'immunité - limites et méthodes de mesure.</p> <p>EN 60950 A4, A11 Sécurité des matériels de traitement de l'information.</p> <p>La système d'assurance de la qualité de DISC garantit la conformité.</p> <p>Fabricant:</p> <p>Date d'établissement 7e la declaration: 14.02.2000</p>

Kap5.fm/31.01.1997/15.02.2000



EG-Konformitätserklärung	EC-Declaration of Conformity	CE-Déclaration de Conformité
<p>mit den Richtlinien 89 / 336 / EWG und 73 / 23 / EWG.</p> <p>Hiermit wird bestätigt, daß das Produkt</p> <p style="text-align: center;">CD-ROM Jukebox</p> <p>mit den folgenden Normen bzw. normativen Dokumenten übereinstimmt:</p> <p>EN 55022: 1998 Kategorie B Grenzwerte und Meßverfahren für Funkstörungen von informationstechnischen Einrichtungen.</p> <p>EN 50082-1: 1998 Störfestigkeit von informationstechnischen Einrichtungen.</p> <p>EN 60950 A4, A11 Sicherheit von Einrichtungen der Informationstechnik.</p> <p>Das Qualitätssicherungssystem der DISC garantiert die Konformität.</p> <p>Ausstelldatum: 14.02.2000</p>	<p>per 89 / 336 / EEC and 73 / 23 / EWG.</p> <p>This is to confirm with that the product</p> <p style="text-align: center;">CD-ROM Jukebox</p> <p>is in compliance with the following standards or other normative documents:</p> <p>EN 55022: 1998 class B Limits and methods of radio interference characteristics of information technology equipment.</p> <p>EN 50082-1: 1998 Information technology equipment-Immunity Characteristics- Limits and methods of measurement.</p> <p>EN 60950 A4, A11 Safety of information technology equipment.</p> <p>DISC quality assurance system assures compliance.</p> <p>Date of issue of the declaration: 02-14-2000</p>	<p>avec 89 / 336 / CEE et 73 / 23 / EWG.</p> <p>Nous déclarons que le produit</p> <p style="text-align: center;">Jukebox CD-ROM</p> <p>est conforme aux normes ou autres documents normatifs suivants:</p> <p>EN 55022: 1998 class B Limites et méthodes de mesure des caractéristiques de perturbation radioélectriques produites par les appareils de traitement de l'information.</p> <p>EN 50082-1: 1998 Appareils de traitements l'information - caractéristiques d'immunité - limites et méthodes de mesure.</p> <p>EN 60950 A4, A11 Sécurité des matériels de traitement de l'information.</p> <p>La système d'assurance de la qualité de DISC garantit la conformité.</p> <p>Date d'établissement 7e la declaration: 14.02.2000</p>